

Features

- DELIVERS TIMED OUTPUT PULSES DETERMINED BY EXTERNAL COMPONENTS
- RETRIGGERABLE OPERATION
- HIGH IMMUNITY TO POWER TRANSIENTS
- ACTIVE PULLUP COMPLEMENTARY OUTPUTS
- INVERTING AND NON-INVERTING TRIGGER INPUTS
- 3.5 VOLTS (MIN) NOISE IMMUNITY

General Description

The Teledyne Semiconductor 347 Dual Retriggerable Monostable Multivibrator is a versatile monostable delivering timed output pulses when triggered. The output pulse width is determined by the RC time constant of externally connected components. For increased flexibility, provision has been made for inverting and non-inverting trigger inputs. Complementary active pullup outputs are also provided.

Logic Diagram

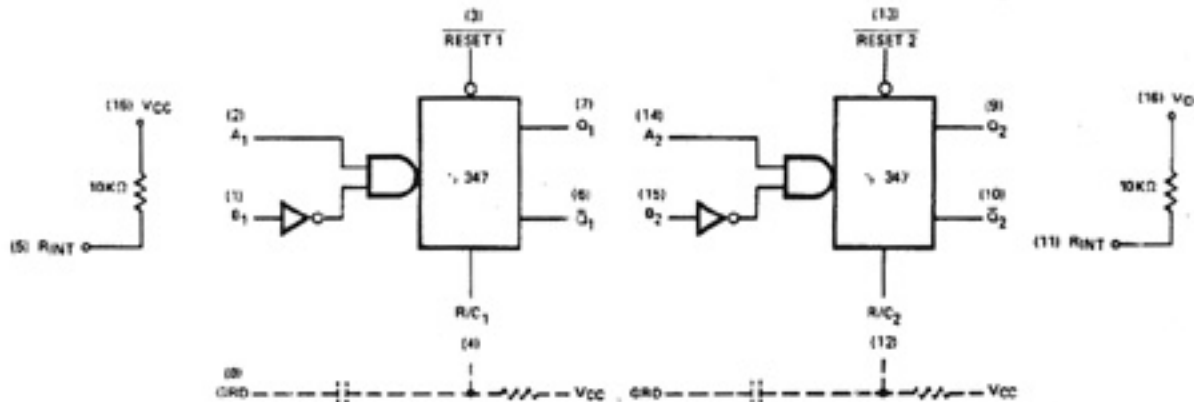

Equivalent Circuits



Specifications

I_{CC} (WORST CASE)	40 mA @ 13 V, 50 mA @ 16 V			
* t_{PD}	500 ns	650 ns	650 ns	750 ns
I/O FUNCTION FOR t_{PD}	A+ Q+	A+ Q-	B- Q+	B- Q-

*Add 30 C to these times for $C > .001\mu F$

NOTE:
 I_{CC} is tested at $V_{CC} + 1$ Volt (+13V for C type and +16V for A type) and is guaranteed across the applicable temperature range. t_{PD} is guaranteed at $V_{CC} \pm 1V$ and across applicable temperature range with the output loaded with 5 unit loads.
 See page 12 for electrical summary data.

Switching Time Waveform

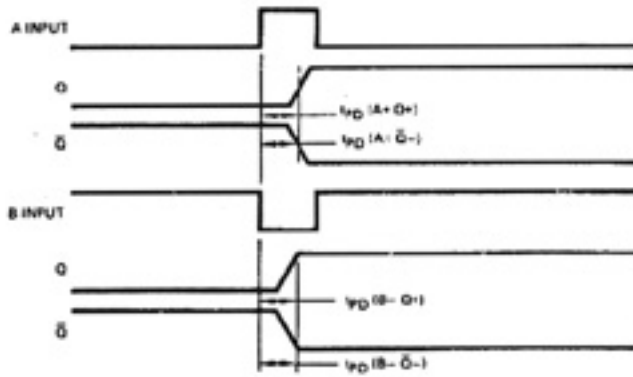

Loading Table

347

PINS	FUNCTION	LOADING
A, B	Trigger inputs	1 UL
RESET	Reset input	2 UL
Q, \bar{Q}	Outputs	5 UL

Typical Performance Characteristics

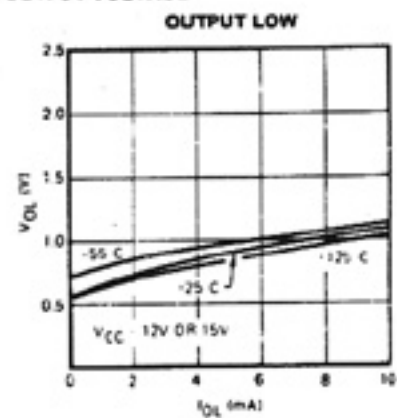
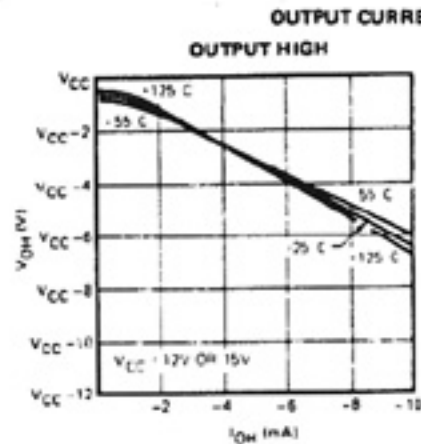
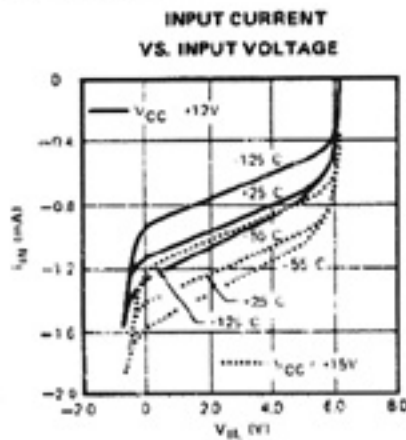

PULSE WIDTH VS. R/C VARIATION

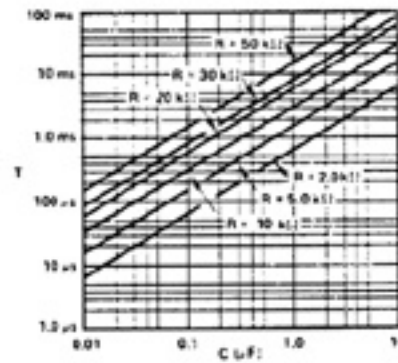
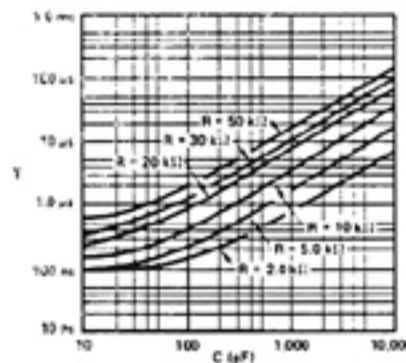

MINIMUM INPUT PULSE WIDTH VS. C

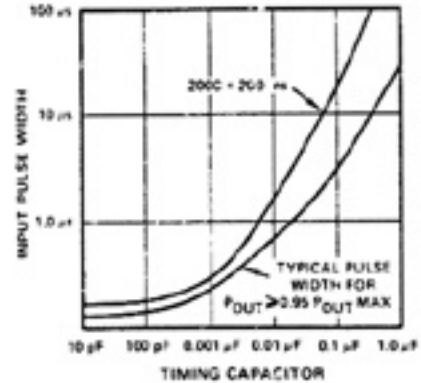

P_{OUT} (NORMALIZED) VS. P_{IN} AS A FUNCTION OF R

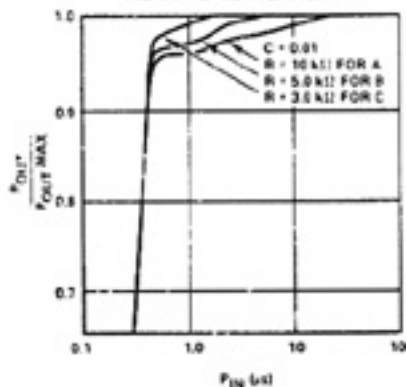

P_{OUT} (NORMALIZED) VS. P_{IN} AS A FUNCTION OF C

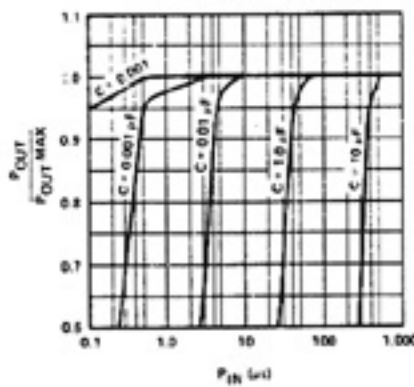

PROPAGATION DELAY VS. C

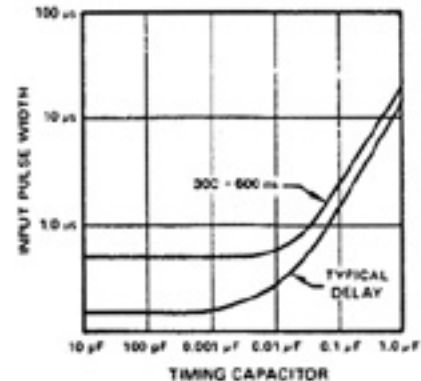

Typical Applications

FUNCTIONAL DESCRIPTION

The HiNIL 347 Dual Retriggerable Monostable Multivibrator, or more commonly a retriggerable one shot, delivers timed output pulses whose width is determined by external components. The pulse width of the output is given by $P_W \approx .31 RC$ where R is the external resistor value in ohms and C is the timing capacitor value in farads.

Component limits:

$$3K\Omega \leq R \leq 30K\Omega$$

$$0 < C < 10\mu F$$

The 347 has provision for both inverting and non-inverting trigger inputs. In addition, the device is retriggerable—the output pulse can be extended by triggering the input before the output pulse is terminated simplifying the generation of output pulses of extremely long duration. The overriding RESET input permits termination of the output pulse at a predetermined time independent of the timing components R and C . The retrigger capability can be inhibited by connecting the Q output to the inverting input.

The 347 is provided with complementary active pullup outputs capable of sourcing 5 mA at 7 volts.

TIMING REQUIREMENTS

- Minimum Time Required Between Input Pulses 300 ns
- Minimum Input Pulse Width $P \geq 200 C + 200$ ns

DESIGNERS GUIDE

The pulse width of the output is determined by the RC time constant of externally connected components. The output pulse width is given by $P_W \approx .31 RC$.

Figures 1, 2 and 3 summarize the various I/O pulses for normal, retrigger and reset modes of operation. The retrigger capability can be inhibited by connecting the output to the inverting input.

If RESET is allowed to go high while the trigger input is true (A high or B low), the device will retrigger as shown in Figure 3B.

The external resistor is connected to V_{CC} and the capacitor to ground. This configuration makes the 347 immune to power transients and overcomes false triggering tendency.

TYPICAL I/O PULSES
NORMAL ONE SHOT OPERATION ($P_W \approx .31 RC$)

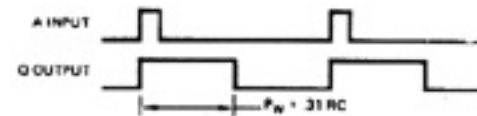

NON-INVERTING TRIGGER INPUT

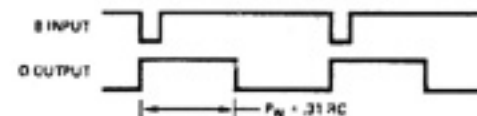

INVERTING TRIGGER INPUT

Figure 1

TYPICAL I/O PULSES
CONTROL UTILIZING RETRIGGER PULSE

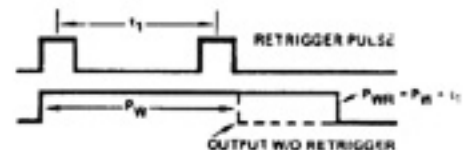

Figure 2

TYPICAL I/O PULSES
CONTROL UTILIZING RESET INPUT

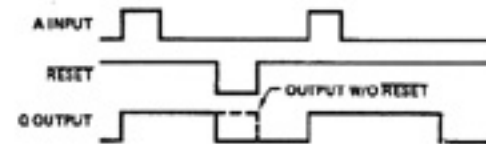

Figure 3A

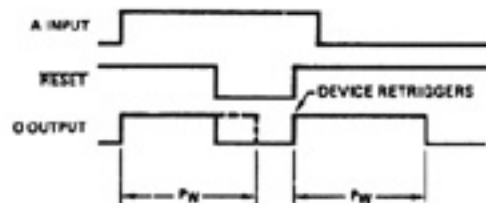

Figure 3B

APPLICATIONS

The circuits shown are some common one shot applications.

A. AC Line Detector

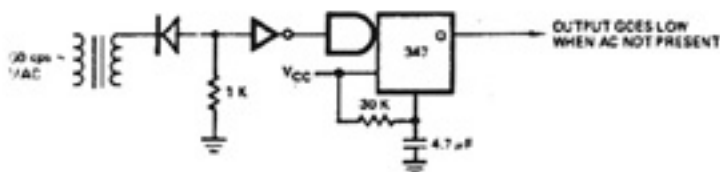
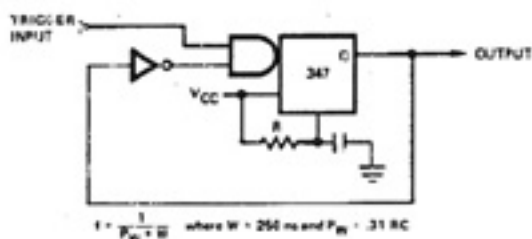
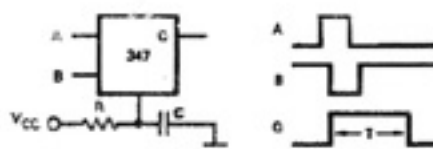

Figure A shows a method of monitoring an AC input source and generates a level to monitor the presence of the AC signals. The retrigger capability of the 347 is utilized when the output period is slightly longer than the 60 cps (or 120 or 240 cps) of the AC source. As long as the 60 cps clock is present, it re-triggers the one shot and extends the high state one more period. If the AC source goes away, no retrigger pulse will occur and the one shot will "time out" (go low) indicating loss of AC. This output could be used to initiate a counter whose output displays how long AC was not present.

B. Free-Running Multivibrator



C. Coincidence Detector



If A is high at the same time B is low, an output pulse will occur. If both signals to be detected are positive-going, one must be inverted before applying it to input B.

D. Envelope Coincidence Detector

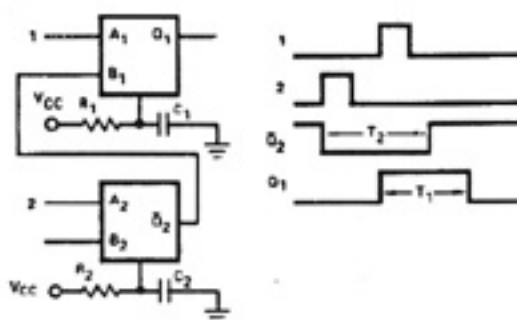

Output Q1 occurs if input 1 is present within time, T_2 , after the beginning of input 2.

An application note on the 347 is presently available and presents a detailed description of the operation of the monostable and presents additional applications data including voltage to frequency converters, frequency to voltage converters, and frequency division.